

Name _____

SUN, EARTH, AND MOON REVIEW

1. Label the Southern and Northern Hemispheres.

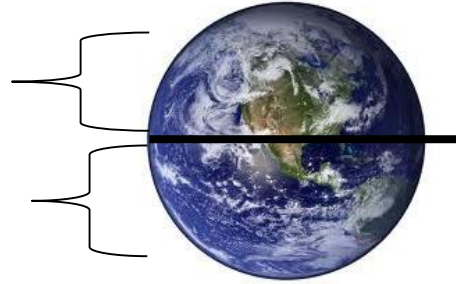

Definitions

Word	Definition	Picture
Rotation		
Revolution		
Axis		
Tilt		
Solar Eclipse		
Lunar Eclipse		
Spring Tide		
Neap Tide		

Rotation and Revolution

2. What movement causes day and night on Earth?

3. The letters in the picture are examples of what movements?

A)

B)

C)

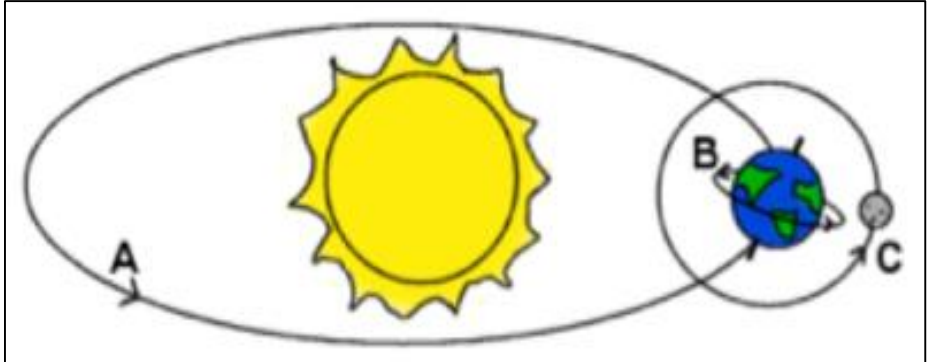

4. How long does it take the Moon to revolve around the Earth?

5. How long does it take the Earth to complete one rotation?

6. How long does it take Earth to revolve around the Sun?

7. What is Leap Year and why do we need it?

8. Where does the moon get its light from?

9. Which letter in the picture are experiencing day?

10. Which letter in the picture are experiencing night?

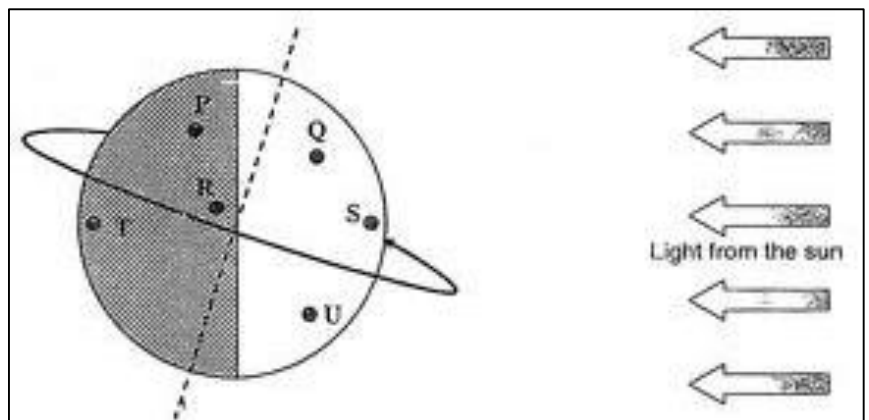

11. Why is the rotation of Earth important?

Seasons

12. Name the four seasons and put them in the correct order.

13. What causes Earth's seasons?

14. If it's summer in the Northern Hemisphere, what season is it in the Southern Hemisphere?

15. What season is the Southern Hemisphere experiencing in the picture?

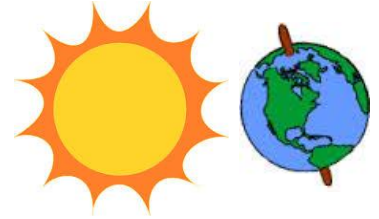

16. What season is the Northern Hemisphere experiencing?

17. Solar Eclipses occur during which moon phase?

18. Lunar Eclipses occur during which moon phase?

19. Label the seasons each hemisphere is experiencing.

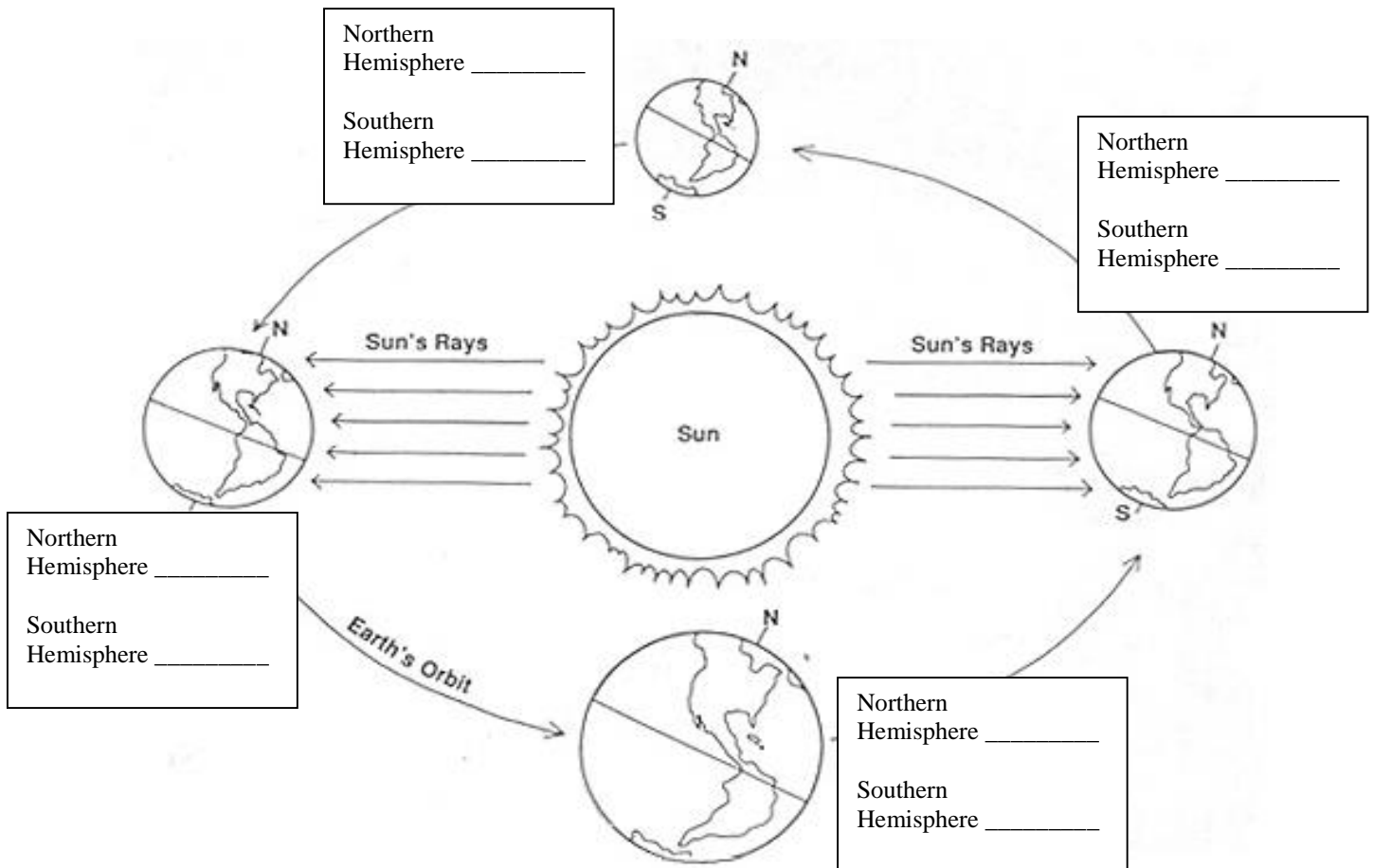

Tides

20. What causes Earth's tides?

21. How many high tides and low tides does Earth experience every day?

22. Using the picture below label where Earth would be experiencing a high tide and a low tide.

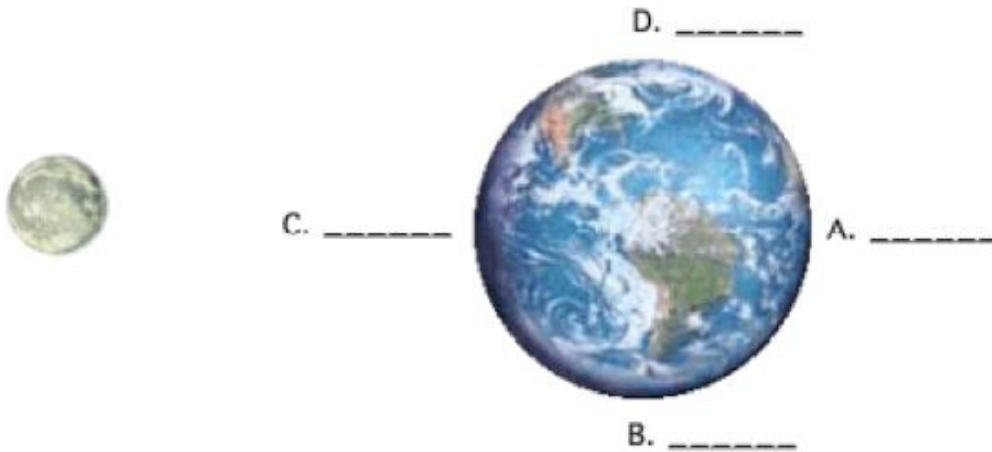

23. During what tide phase would the Earth have Higher than normal high tides?

24. During what tide phase would the Earth have Lower than normal high tides?

Label which picture is a neap tide and which is a spring tide

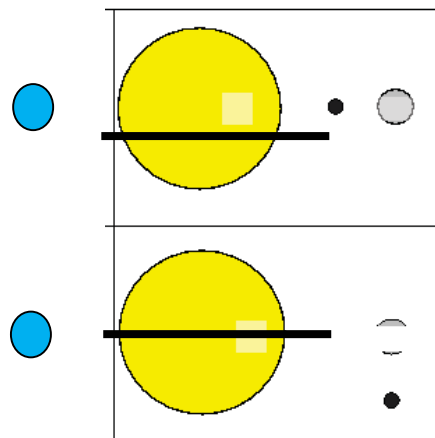
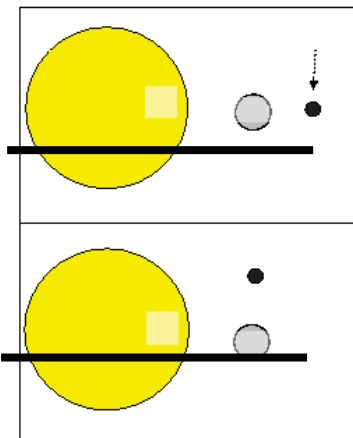

25. What moon phases are present during a Neap Tide?

26. What moon phases are present during a Spring Tide?

Moon Phases

27. Solar Eclipses occur during which moon phase?

28. Lunar Eclipses occur during which moon phase?

Label and draw the moon phases. Don't forget to look at the position of the Sun.

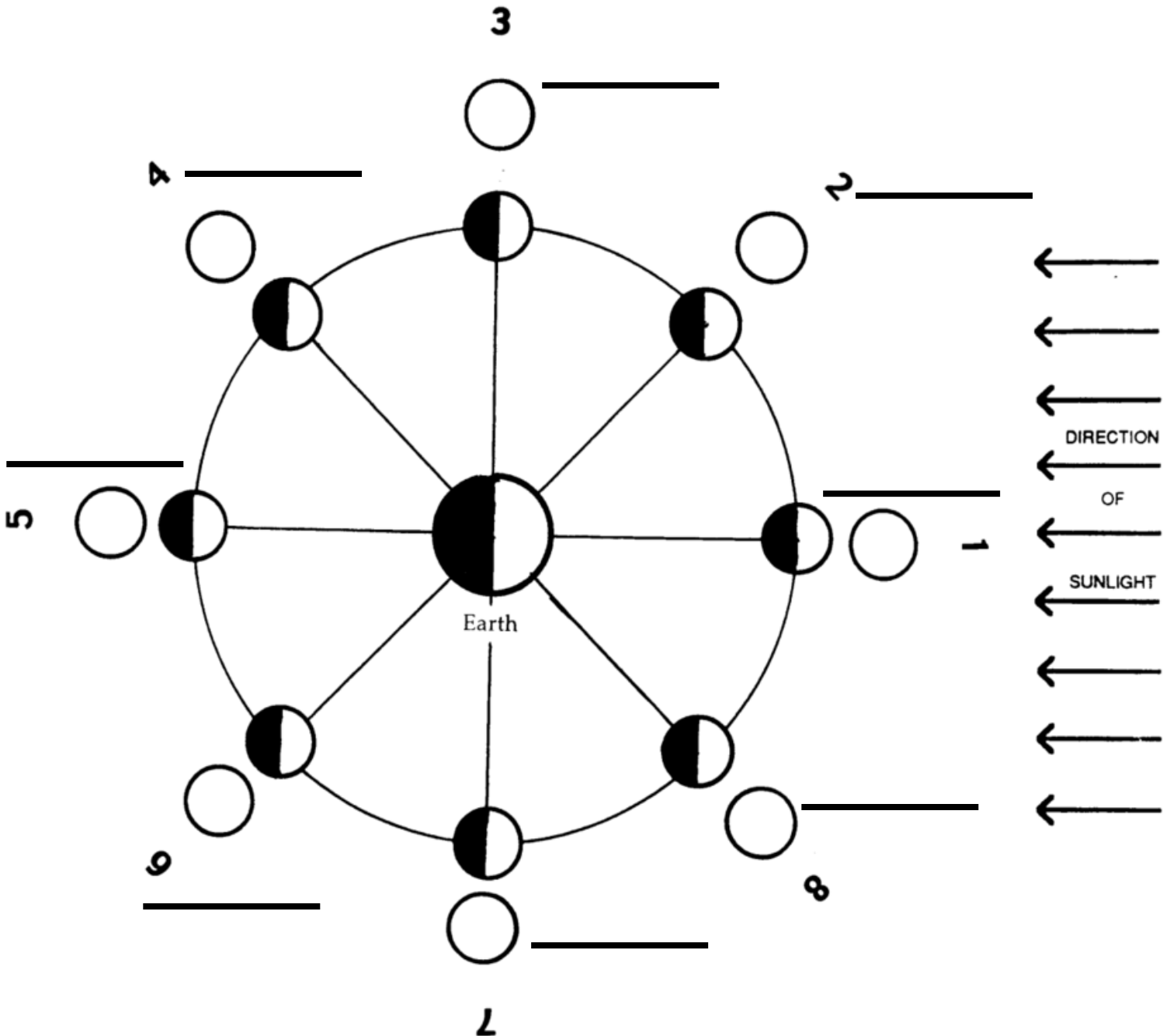

Label and draw the moon phases. Don't forget to look at the position of the Sun.

Sun's Rays

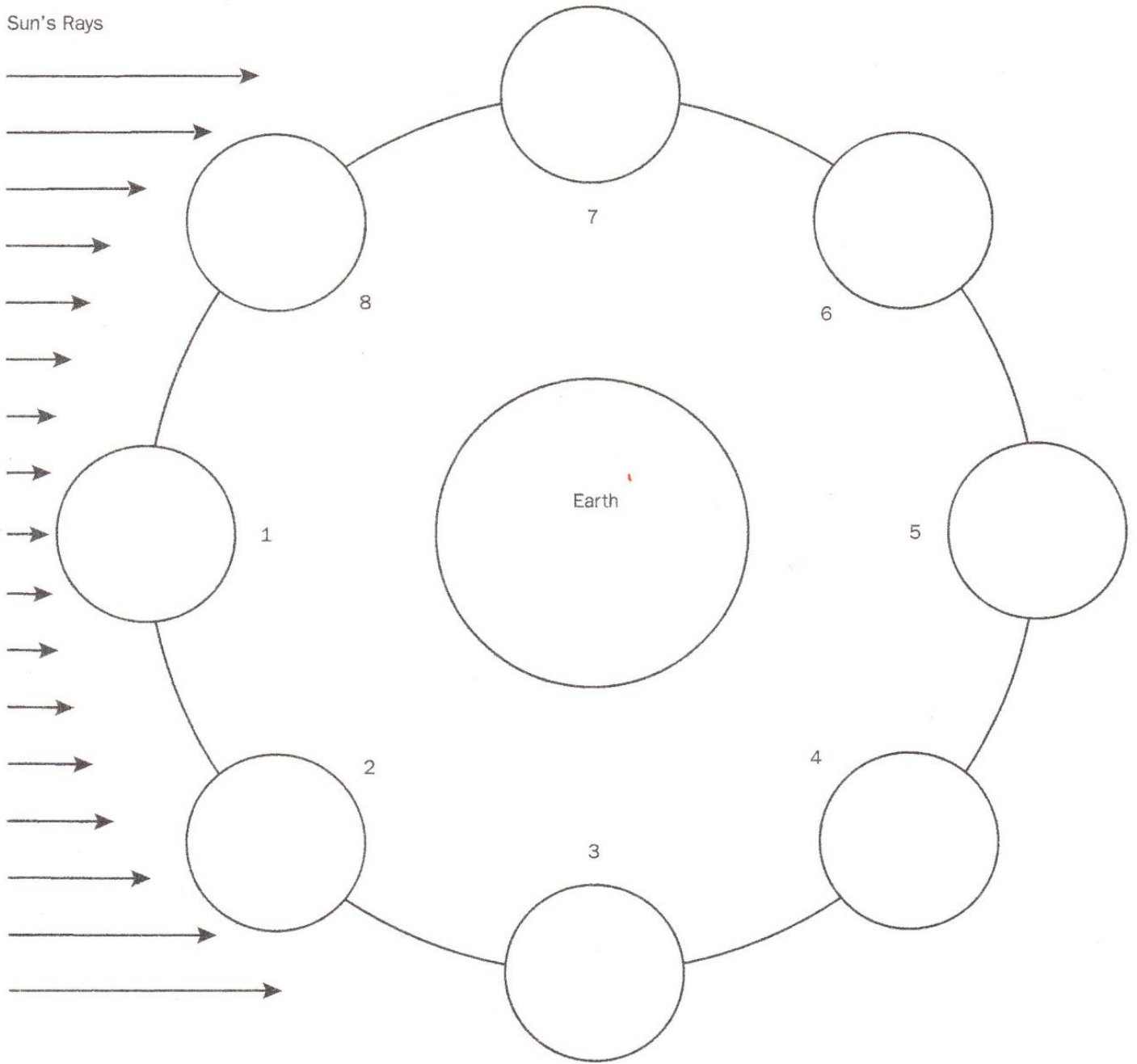

1. _____

5. _____

2. _____

6. _____

3. _____

7. _____

4. _____

8. _____